

**Gondella**  **CZ**  
S.r.o.

Výrobce variabilního regálového systému

**KATALOG LEHKÝCH SKLADOVÝCH REGÁLŮ**

**CATALOGUE OF LIGHT STORAGE RACKS**

**KATALOG DEN LEICHTEN LAGERREGALEN**

Říkov 266  
552 03 Česká Skalice  
Czech Republic

tel.: +420 491 40 12 11  
fax: +420 491 40 12 12

e-mail: [info@gondella.cz](mailto:info@gondella.cz)  
[www.gondella.cz](http://www.gondella.cz)

## CZ

*Regály firmy Gondella určené do domácnosti jsou vyráběny z prvotřídního materiálu s vysoce kvalitní epoxy povrchovou úpravou.*

*Na speciální žádost mohou být objednány i jiné typy, velikosti, kombinace nebo barvy než jsou uvedeny v tomto katalogu.*

*Vedle této řady regálových jednotek pro domácí použití nabízí Gondella CZ kompletní modulový systém obchodního vybavení. Pro základní představu prosím navštivte stránky [www.gondella.com](http://www.gondella.com). Na žádost Vám můžeme zaslat kompletní katalog.*

*Politikou firmy Gondella je neustálé zdokonalování a rozvoj. Proto si vyhrazujeme právo změnit informace, které byly poskytnuty, bez předešlého oznámení. Všechny informace musí být považovány za přibližné. Katalog zůstává ve vlastnictví firmy Gondella CZ.*

## GB

*Gondella Domestic shelving units are made of first class material with a high quality epoxy coated finish.*

*Other types, sizes, combinations or colours than figured in this catalogue, can be offered on special request.*

*Next to this range of household shelving units, Gondella CZ offers a complete system of modular shop fitting equipment. For a short introduction, please refer to [www.gondella.com](http://www.gondella.com). A complete catalogue can be sent on request.*

*Gondella CZ's policy is one of continuous improvement and development. We therefore reserve the right to amend the information given without prior notice; all the information has to be considered as approximate. The catalogues remain the sole property of Gondella CZ.*

## D











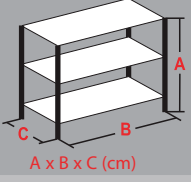
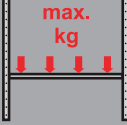



























*Die Gondella Haushaltregale sind hergestellt aus Qualitätsmaterialien mit Endausführung in Epoxy.*

*Andere Typen, Abmessungen, Zusammensetzungen oder Farben können angeboten werden gemäß Ihre Sonderanfrage.*











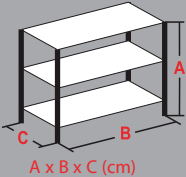
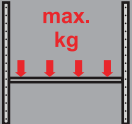

*Neben dieses Sortiments von Haushaltregale bietet Gondella CZ noch eines komplettes System von modularen Ladenbauregale an. Ein kurzes Übersicht dieses Produkts finden Sie auf: [www.gondella.com](http://www.gondella.com). Falls Interesse an diesem Sortiment, schicken wir Ihnen gerne den kompletten Katalog zu.*

*Die Politik von Gondella CZ besteht daraus die Produkte permanent zu verbessern und weiterzuentwickeln. Wir behalten uns das Recht vor die Daten ohne Vorausmeldung zu ändern, alle technische Daten sind approximativ. Die Kataloge gehören Gondella CZ.*

## Přehled - Summary - Übersicht

Modul Module Modul	 A x B x C (cm)	Police Shelf Boden	 max. kg	 max. kg	Sestavení Assembly Montage	Přístavba Extension Anbau	Strana Page Seite
Variant 4	160 x 80 x 35	4x	50	200			3÷6
Variant 4	180 x 80 x 35	4x	50	200			3÷6
Variant 5	180 x 80 x 35	5x	50	200			7÷10
Variant 6	180 x 80 x 35	6x	50	200			7÷10
Maxi	200 x 100 x 50	4x	100	400			11÷12
Special	200 x 100 x 40	5x	100	400			13÷14
Varioclick	185 x 80 x 35	4x	65	260			15÷18
Varioclick	168 x 80 x 35	4x	65	260			15÷18
Maxiclick	202 x 100 x 50	4x	100	500			19÷20
Maxiclick	202 x 100 x 40	4x	100	500			19÷20
Vario Pro 180	180 x 90 x 40	5x	175	875			21÷22
Titan	200 x 100 x 50	4x	250	1000			23÷24
Lahvový regál Rack for bottles Regal für Flaschen	160 x 80 x 35	3x	40x  0,7-1 l	200			25÷26
Opal 3	90 x 75 x 30	3x	30	90			27÷28
Opal 4	125 x 75 x 30	4x	30	120			27÷28
Shadow 1	113 x 80 x 32	4x	30	90			29÷30
Shadow 2	185 x 80 x 32	6x	30	120			29÷30
Mini	90 x 45 x 30	4x	30	120			31÷32

## Přehled - Summary - Übersicht

Modul Module Modul		Police Shelf Boden			Sestavení Assembly Montage	Přístavba Extension Anbau	Strana Page Seite
Příslušenství pro Variant - Accessories for Variant - Zubehör für Variant							
Lahvová police Shelf for bottles Flaschenboden	80 x 35		8x  0,7-1 l				35÷36
Zeleninová police Vegetable shelf Gemüseboden	72 x 35 x 5		20				37÷38
Lahvový rošt Grid for bottles Flaschengitter	80 x 35 x 50		40x  0,7-1 l				39÷40
Koš na brambory Potato basket Kartoffelkorb	80 x 35 x 50		50				41÷42
Mini Space	175 x 45 x 30	6x	30	180			31÷32
Mini Space	175 x 45 x 30	4x	30	120			31÷32
Standard 3	75 x 75 x 30	3x	50	200			33÷34
Standard 4	150 x 75 x 30	4x	50	200			33÷34



## *Variant 4 180*

180x80x35

## *Variant 4 160*

160x80x35



### **CZ**



Víceúčelový regál (využití např. dílna, spižárna, sklep apod.). Stojky s perforací s roztečí 25mm umožňují nastavení polic do různých výšek.







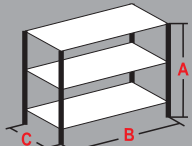
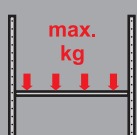
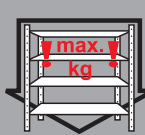

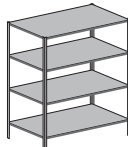
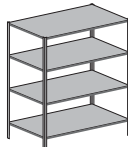
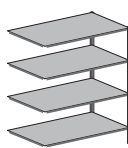
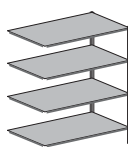





### **GB**

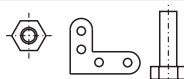





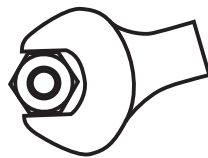



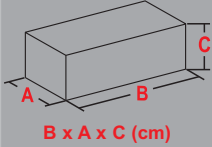
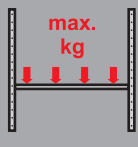

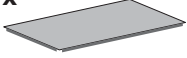
Multi-purpose rack (using e.g. workshop, pantry, cellar etc.). Perforated uprights with a 25mm pitch enable shelves in different height positions.

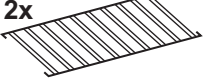
### **D**

Mehrzweckregal (Ausnützung z.B. Werkstatt, Speisekammer, Keller u.ä.). Gelochte Säule mit 25mm Lochungsschritt ermöglichen eine Bödenmontage in verschiedenen Höhen.

Modul Module Modul	 A x B x C (cm)	Police Shelf Boden	Stojka Upright Säule	 max. kg	 max. kg	 Kg	* Barva Color Farbe
	Variant 4 160x80x35 (E1.6834) (H1.6560)	4x	4x	50	200	9,5	00 = RAL1013 03 = RAL9010 55 = hamrsch. 90 = ZN
	Variant 4 180x80x35 (E1.8834) (H1.6580)	4x	4x	50	200	10	
	Variant 4 160x80x35 (E1.6834A) (H2.6570)	4x	2x	50	200	8	
	Variant 4 180x80x35 (E1.8834A) (H2.6590)	4x	2x	50	200	8	

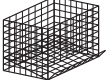
Technická data Technical data Technische Daten		 mm	 Kg	
	80x35 cm	0,5	1,42	
	160 cm (E5.1630) (H4.6816)	1	0,62	
	180 cm (E5.1830) (H4.6817)	1	0,7	
	48mb		0,47	48x  M 6x10 2x  48x  M 6 2x  4x  8x 
* 00 03 55 90	Barva Slonová kost Bílá Kladívková šedá Pozink	Color Yvory White Grey hammerite Zinc coated	Farbe Perlweiß Weiß Hammerschlag Verzinkt	  

Příslušenství Accessories Zubehör		 B x A x C (cm)	 max. kg	 Kg		* Barva Color Farbe
1x 	1x	Police Shelf Boden	80x35 (E3.8035)	50	1,42	00 = RAL1013 03 = RAL9010 55 = hamrsch. 90 = ZN
2x 	2x	Police Shelf Boden	80x35 (H3.6813)	50	2,84	
2x 	2x	Lahvová police Shelf for bottles Flaschenboden	80x35 (H3.6815)	2x8  0,7-1 l	1,95	
2x 	2x	Zeleninová police Vegetable shelf Gemüseboden	72x35x5 (ZP.8035) (H3.6814)	20	5	
1x 	1x	Lahvový rošt Grid for bottles Flaschengitter	80x35x50 (H3.6812)	40x  0,7-1 l	3,05	
1x 	1x	Koš na brambory Potato basket Kartoffelkorb	80x35x50 (KB.8035) (H3.6816)	50	6,3	

* 00	Barva Slonová kost	Color Yvory	Farbe Perlweiß
03	Bílá	White	Weiß
55	Kladívková šedá	Grey hammerite	Hammerschlag
90	Pozink	Zinc coated	Verzinkt







## Variant 6 180x80x35

## Variant 5 180x80x35



### CZ



Víceúčelový regál (využití např. dílna, spižirna, sklep apod.). Stojky s perforací s roztečí 25mm umožňují nastavení polic do různých výšek.







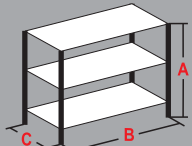
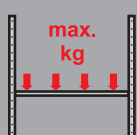
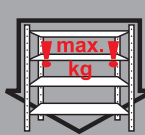

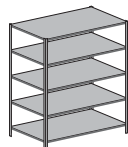
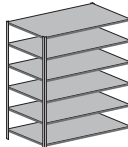
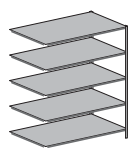
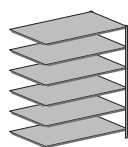

### GB

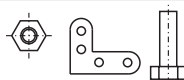

Multi-purpose rack (using e.g. workshop, pantry, cellar etc.). Perforated uprights with a 25mm pitch enable shelves in different height positions.







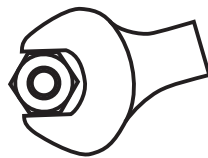

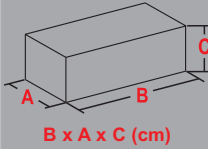
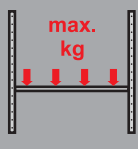

### D

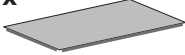
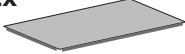
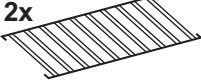
Mehrweckregal (Ausnützung z.B. Werkstatt, Speisekammer, Keller u.ä.). Gelochte Säule mit 25mm Lochungsschritt ermöglichen eine Bödenmontage in verschiedenen Höhen.

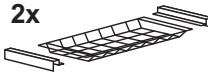
Modul Module Modul	 A x B x C (cm)	Police Shelf Boden	Stojka Upright Säule	 max. kg	 max. kg	 Kg	* Barva Color Farbe
	<b>Variant 5</b> 180x80x35 (E1.8835) (E7.8835)	5x	4x	50	200	11,5	00 = RAL1013 03 = RAL9010 55 = hamrsch. 90 = ZN
	<b>Variant 6</b> 180x80x35 (E1.8836) (E7.8836)	6x	4x	50	200	13	
	<b>Variant 5</b> 180x80x35 (E1.8835A) (E8.8835)	5x	2x	50	200	9,5	
	<b>Variant 6</b> 180x80x35 (E1.8836A) (E8.8836)	6x	2x	50	200	11	

Technická data Technical data Technische Daten		 mm	 Kg	
	80x35 cm	0,5	1,42	
	180 cm (E5.1830) (H4.6817)	1	0,7	
	56mb(E6.P056) 48mb(E6.P048)		0,44 0,39	56x  M 6x10    56x  M 6    4x  48x  M 6x10    48x  M 6    4x 

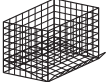
* 00 03 55 90	Barva Slonová kost Bílá Kladívková šedá Pozink	Color Yvory White Grey hammerite Zinc coated	Farbe Perlweiß Weiß Hammerschlag Verzinkt			

Příslušenství Accessories Zubehör		 B x A x C (cm)	 max. kg	 Kg		* Barva Color Farbe
1x 	1x	Police Shelf Boden	80x35 (E3.8035)	50	1,42	00 = RAL1013 03 = RAL9010 55 = hamrsch. 90 = ZN
2x 	2x	Police Shelf Boden	80x35 (H3.6813)	50	2,84	
2x 	2x	Lahvová police Shelf for bottles Flaschenboden	80x35 (H3.6815)	2x8  0,7-1 l	1,95	 00 = RAL1013 03 = RAL9010
2x 	2x	Zeleninová police Vegetable shelf Gemüseboden	72x35x5 (ZP.8035) (H3.6814)	20	5	
1x 	1x	Lahvový rošt Grid for bottles Flaschengitter	80x35x50 (H3.6812)	40x  0,7-1 l	3,05	
1x 	1x	Koš na brambory Potato basket Kartoffelkorb	80x35x50 (KB.8035) (H3.6816)	50	6,3	

* 00	Barva Slonová kost	Color Yvory	Farbe Perlweiß
03	Bílá	White	Weiß
55	Kladívková šedá	Grey hammerite	Hammerschlag
90	Pozink	Zinc coated	Verzinkt



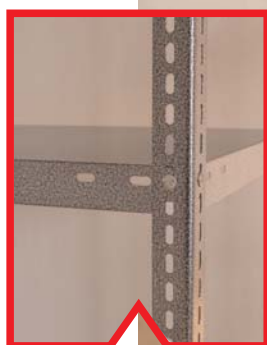

## *Maxi* 200x100x50



### CZ



Dvoumetrový regál s velkým úložným prostorem. Je určen pro větší zatížení (max.400kg). Perforace stojáků 25mm umožňuje různé nastavení polic. Jsou dvě možnosti sestavení: 200x100x50cm a 100x200(100+100)x50cm.







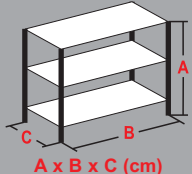
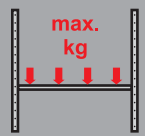

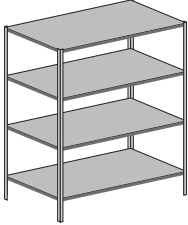
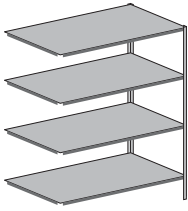

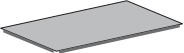

### GB

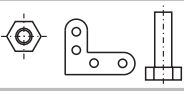
A two meters high rack with a big load capacity. It is used where greater loading capacity is needed (max.400kg). The 25mm upright perforation enables adjusting of the shelves position. There are two assembly possibilities:  
200x100x50cm and  
100x200(100+100)x50cm.



### D

Ein zwei Meter hohes Regal mit großer Tragkraft, geeignet für größere Belastungen. Gelochte Säule mit einem Lochungsschritt von 25mm ermöglichen eine flexible Bödenmontage. Es gibt zwei Aufbaumöglichkeiten:  
200x100x50cm und  
100x200(100+100)x50cm.

Modul Module Modul	 A x B x C (cm)	Police Shelf Boden	Stojka Upright Säule	 max. kg	 max. kg	 Kg	* Barva Color Farbe
	<b>Maxi</b> <b>200x100x50</b> <b>(E9.0154)</b> <b>(H1.6750)</b>	<b>4x</b>	<b>4x</b> <small>(8Ks-Pcs-Stk)</small>	<b>100</b>	<b>400</b>	<b>20,5</b>	00 = RAL1013 03 = RAL9010 55 = hamrsch. 90 = ZN
	<b>Maxi</b> <b>200x100x50</b> <b>(E9.0154A)</b> <b>(H2.6760)</b>	<b>4x</b>	<b>2x</b> <small>(4Ks-Pcs-Stk)</small>	<b>100</b>	<b>400</b>	<b>19</b>	

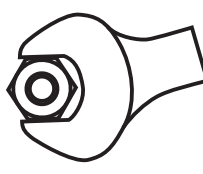
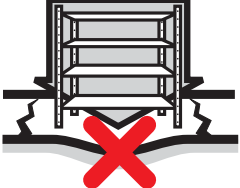
Technická data Technical data Technische Daten	 mm	 Kg	
	<b>100x50 cm</b>	<b>0,7</b>	<b>4</b>
	<b>200 cm</b> <b>(100+100)</b> <b>(E5.1035)</b> <b>(H4.6861)</b>	<b>1,5</b>	<b>0,7</b>
	<b>200 cm</b> <b>(E5.2035)</b>	<b>1,5</b>	<b>1,4</b>
	<b>80vb</b> <b>(E6.P080)</b>	<b>1,13</b>	<b>80x</b>  <b>M 6x10</b> <b>2x</b>  <b>80x</b>  <b>M 6</b> <b>2x</b>  <b>4x</b>  <b>4x</b>  <b>16x</b> 
* 00 03 55 90	<b>Barva</b> Slonová kost Bílá Kladívková šedá Pozink	<b>Color</b> Yvory White Grey hammerite Zinc coated	<b>Farbe</b> Perlweiß Weiß Hammerschlag Verzinkt

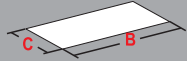
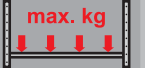
Příslušenství Accessories Zubehör	 B x C (cm)	 max. kg	 Kg	* Barva Color Farbe
<b>1x</b> 	<b>1x</b> Police Shelf Boden <b>100x50</b> <b>(E3.1050)</b>	<b>100</b>	<b>4</b>	00 = RAL1013 03 = RAL9010 55 = hamrsch. 90 = ZN
<b>2x</b> 	<b>2x</b> Police Shelf Boden <b>100x50</b> <b>(H3.6862)</b>	<b>100</b>	<b>8</b>	

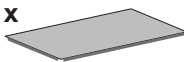
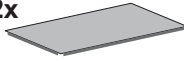



*Special*  
200x100x40

## CZ

Dvoumetrový regál s velkým úložným prostorem. Je určen pro větší zatížení (max.400kg). Perforace stojáku 25mm umožňuje různé nastavení polic. Jsou dvě možnosti sestavení: 200x100x40cm a 100x200(100+100)x40cm.

## GB

A two meters high rack with a large load capacity. It is used where greater loading capacity is needed (max.400kg). The 25mm upright perforation enables adjusting of the shelves position. There are two assembly possibilities: 200x100x40cm and 100x200(100+100)x40cm.

## D

Ein zwei Meter hohes Regal mit großer Tragkraft, geeignet für größere Belastungen. Gelochte Säule mit einem Lochungsschritt von 25mm ermöglichen eine flexible Bödenmontage. Es gibt zwei Aufbaumöglichkeiten: 200x100x40cm und 100x200(100+100)x40cm.

Modul Module Modul	 A x B x C (cm)	Police Shelf Boden	Stojka Upright Säule	 max. kg	 max. kg	 Kg	* Barva Color Farbe
	<b>Special</b> <b>200x100x40</b> (E9.0145) (E9.9045)	5x	4x (8Ks-Pcs-Stk)	100	400	21,5	00 = RAL1013 03 = RAL9010 55 = hamrsch. 90 = ZN
	<b>Special</b> <b>200x100x40</b> (E9.0145A)	5x	2x (4Ks-Pcs-Stk)	100	400	19	

Technická data Technical data Technische Daten	 mm	 Kg	
	100x40cm	0,7	3,1
	200cm (100+100) (E5.1035) (H4.6861)	1,5	0,7
	200cm (E5.2035)	1,5	1,4
	88vb	1,27	88x  M 6x10 2x 88x  M 6 2x 4x 4x 20x
* 00 03 55 90	Barva Slonová kost Bílá Kladívková šedá Pozink	Color Yvory White Grey hammerite Zinc coated	Farbe Perlweiß Weiß Hammerschlag Verzinkt

Příslušenství Accessories Zubehör	 B x C (cm)	 max. kg	 Kg	* Barva Color Farbe
1x 	1x Police Shelf Boden <b>100x40</b> (E3.1040)	100	3,1	00 = RAL1013 03 = RAL9010 55 = hamrsch. 90 = ZN
2x 	2x Police Shelf Boden <b>100x40</b>	100	6,2	



## Varioclick

185x80x35  
168x80x35



### CZ





Víceúčelový regál (využití např. dílna, spižárna, sklep apod.). Rychlá montáž bez šroubků - systém CLICK (zaklapnutí)!





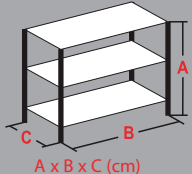
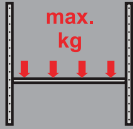

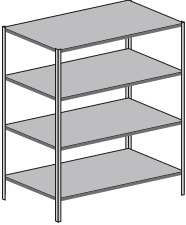

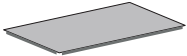

### GB

Multi-purpose rack (using e.g. workshop, pantry, cellar etc.). Quick assembly - no screws needed - system CLICK!

### D

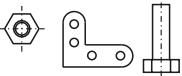







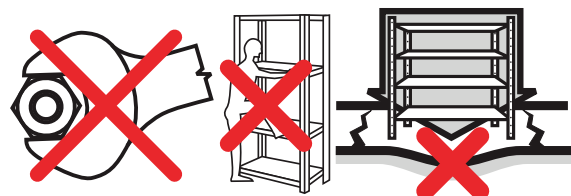

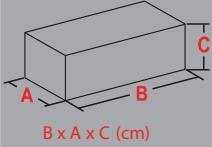
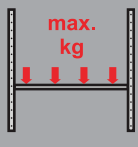

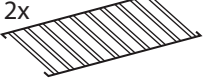

Mehrzweckregal (Ausnutzung z.B. Werkstatt, Speisekammer, Keller u.ä.). Schnellmontage ohne Schrauben - system CLICK (Steckregal)!

Modul Module Modul	 A x B x C (cm)	Police Shelf Boden	Stojka Upright Saule	 max. kg	 max. kg	 Kg	* Barva Color Farbe
	Varioclick 185x80x35 (S6.1980354 )	4x	4x (8Ks-Pcs-Stk)	65	260	10	00 = RAL1013 03 = RAL9010 55 = hamrsch.
	Varioclick 185x80x35 S6.1780354	4x	4x (8Ks-Pcs-Stk)	65	260	9,5	

Technická data Technical data Technische Daten		 mm	 Kg	
	80x35 cm	1	3,2	
	185/3x3 cm (91+95)	1	1,7	
	168/3x3 cm (84+87)	1	1,33	
			0,02	2x  2x  4x  2x 

* 00 03 55	Barva Slonová kost Bílá Kladívková šedá	Color Yvory White Grey hammerite	Farbe Perlweiß Weiß Hammerschlag



Příslušenství Accessories Zubehör						 Barva Color Farbe	
1x		1x	Police Shelf Boden	80x35 (S7.0080351 )	65	1,53	00 = RAL1013 03 = RAL9010 55 = hamrsch.
2x		2x	Police Shelf Boden	80x35 (S7.0080352 )	65	3,06	
2x		2x	Lahvová police Shelf for bottles Flaschenboden	80x35 (H3.6815 )	2x8 	1,95	   
2x		2x	Zeleninová police Vegetable shelf Gemüseboden	72x35x5 (ZP.8035 ) (H3.6814 )	20	5	
1x		1x	Lahvový rošt Grid for bottles Flaschengitter	80x35x50 (H3.6812 )	40x 	3,05	
1x		1x	Koš na brambory Potato basket Kartoffelkorb	80x35x50 (KB.8035 ) (H3.6816 )	50	6,3	

*	Barva	Color	Farbe
00	Slonová kost	Yvory	Perlweiß
03	Bílá	White	Weiß
55	Kladívková šedá	Grey hammerite	Hammerschlag



## Maxiclick

202x100x50

202x100x40

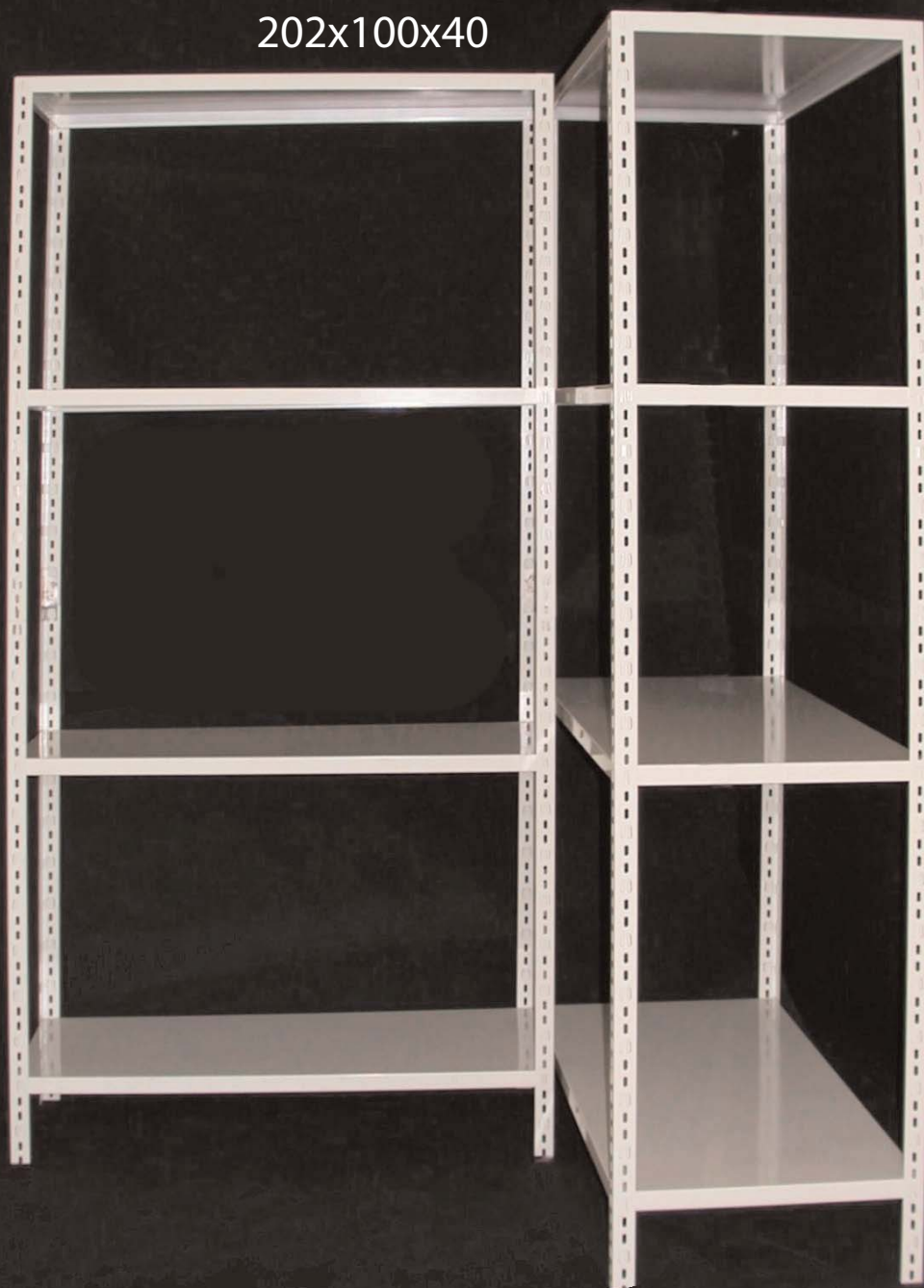

### CZ



Dvoumetrový regál s velkým úložným prostorem. Je určen pro větší zatížení (max.500kg). Jsou dvě možnosti sestavení: 200x100x50/40cm a 100x200(100+100)x50/40cm. Rychlá montáž bez šroubků - systém CLICK (zaklapnutí)!







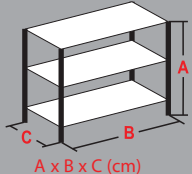
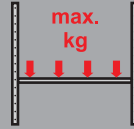
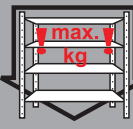

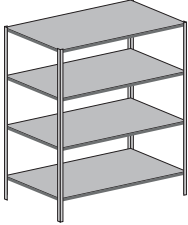
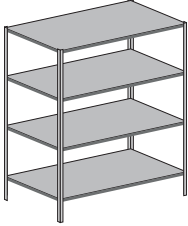

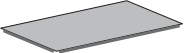

### GB

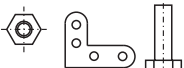



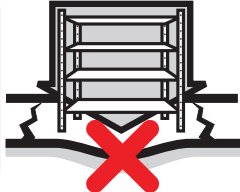

A two meters high rack with a big load capacity. It is used where greater loading capacity is needed (max. 500kg). There are two assembly possibilities: 200x100x50/40cm a 100x200(100+100)x50/40cm. Quick assembly - no screws needed - system CLICK!

### D

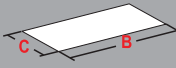
Ein Zwei Meter hohes Regal mit großer Tragkraft, geeignet für größere Belastungen. Es gibt zwei Aufbaumöglichkeiten: 200x100x50/40cm und 100x200(100+100)x50/40cm. Schnellmontage ohne Schrauben - system CLICK ! (Steckregal)!

Modul Module Modul	 A x B x C (cm)	Police Shelf Boden	Stojka Upright Saule	 max. kg	 max. kg	 Kg	* Barva Color Farbe
	Maxiclick 202x100x50 (S6.201050)	4x	4x (8Ks-Pcs-Stk)	100	500	21	00 = RAL1013 03 = RAL9010 55 = hamrsch.
	Maxiclick 202x100x40 (S6.201040)	4x	4x (8Ks-Pcs-Stk)	100	500	17,9	

Technická data Technical data Technische Daten	 mm	 Kg	
	100x50 cm 100x40 cm	0,7 0,7	3,55 2,96
	202 cm (101+101)	1,5	1,5
		0,15	2x  2x  4x  2x  4x 
* 00 03 55	Barva Slonová kost Bílá Kladívková šedá	Color Yvory White Grey hammerite	Farbe Perlweiß Weiß Hammerschlag
  			

Příslušenství Accessories Zubehör	 B x C (cm)	 max. kg	 Kg	* Barva Color Farbe
1x 	1x Police Shelf Boden 100x50 (S7.0010501 )	100	3,55	00 = RAL1013 03 = RAL9010 55 = hamrsch.
2x 	2x Police Shelf Boden 100x50 (S7.0010502 )	100	7,1	
1x 	1x Police Shelf Boden 100x40 (S7.0010401 )	100	2,96	
2x 	2x Police Shelf Boden 100x40 (S7.0010402 )	100	5,92	





## *VarioPro 180* 180x90x40

### CZ

Víceúčelový regál s vysokou nosností. Přestavitelnost polic po 25 mm.

Dvě možnosti sestavení:

- jako skladový regál 180x90x40
- jako pracovní stůl 90x180x40

Rychlá montáž bez šroubků - systém CLICK (zaklapnutí) !

### GB

Multi-purpose rack with a big load capacity.

The shelves are adjustable each 25 mm.

Two assembly possibilities:

- as rack 180x90x40
- as work table 90x180x40

Quick assembly - no screws needed - system CLICK!



### D







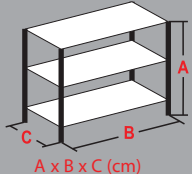
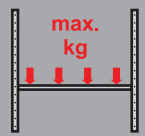

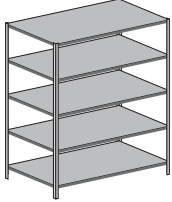
Mehrzweckregal mit Hochbelastbarkeit. Verstellbarkeit der Böden um 25 mm.

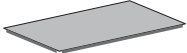

Zwei Aufbaumöglichkeiten:

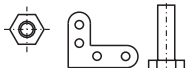



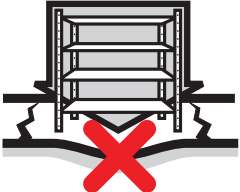

- wie Regal 180x90x40
- wie Arbeitstisch 90x180x40

Schnellmontage ohne Schrauben - System CLICK ! (Steckregal)!

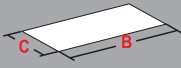
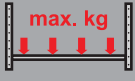
Modul Module Modul	 A x B x C (cm)	Police Shelf Boden	Stojka Upright Saule	 max. kg	 max. kg	 Kg	* Barva Color Farbe
	VarioPro 180 180x90x40 (T2.1890405H )	5x	4x (8Ks-Pcs-Stk)	175	875	21	00 = RAL1013 03 = RAL9010 55 = hamrsch.

Technická data Technical data Technische Daten		 Kg	
	90x40 cm	2.25	
	180 cm (90+90)	0.9	
			2x  2x  4x 
* 00 03 55	Barva Slonová kost Bílá Kladívková šedá	Color Yvory White Grey hammerite	Farbe Perlweiß Weiß Hammerschlag





Příslušenství Accessories Zubehör	 B x C (cm)	 max. kg	 Kg	* Barva Color Farbe
1x  4x 	Police Shelf Boden Konzoly Brackets Konsole 90x40 (2x40+2x90) (T3.0090401H )	175	2.25	00 = RAL1013 03 = RAL9010 55 = hamrsch.
2x  8x 	Police Shelf Boden Konzoly Brackets Konsole 90x40 (4x40+4x90) (T3.0090402H )	175	4.5	

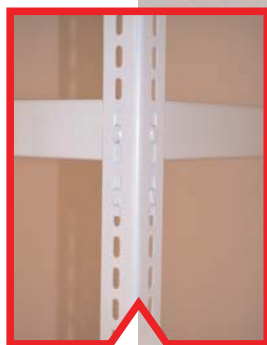

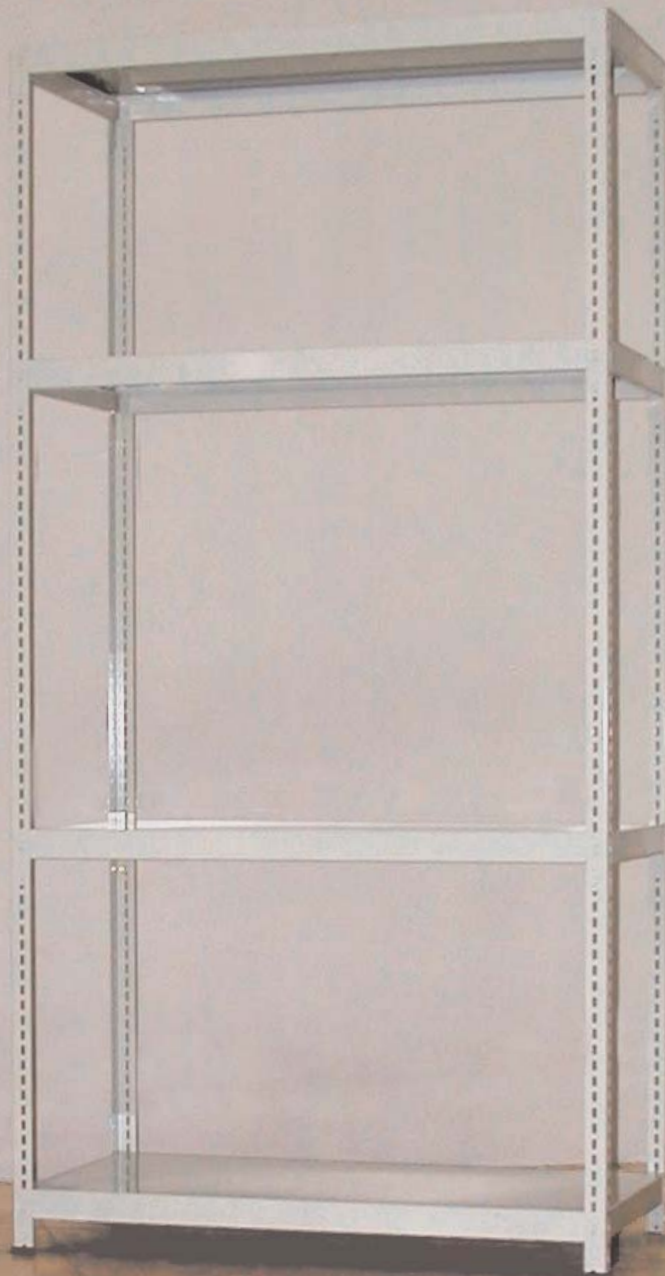

## *Titan* 200x100x50



### CZ



Vysoká nosnost s vyjímečně velkým úložným prostorem - neobyčejně masivní. Rychlá montáž bez šroubků!







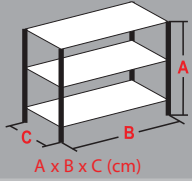
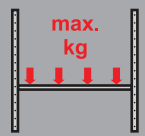

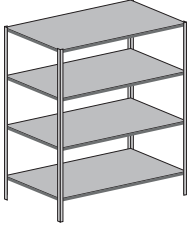
### GB



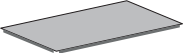
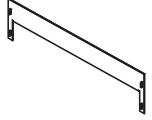

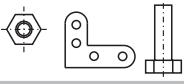

High loading capacity with a large storage space - exceptionally sturdy. Quick assembly - no screws needed!

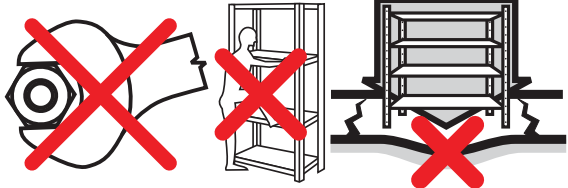
### D

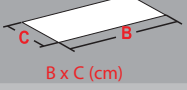
Hochbelastbar mit grosser Lagerfläche - Phänomenal stabil. Schnellmontage ohne Schrauben!

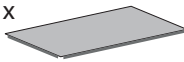
Modul Module Modul		Police Shelf Boden	Stojka Upright Saule				* Barva Color Farbe
	Titan 200x100x50 (T1.2010504B )	4x	4x	250	1000	35	00 = RAL1013 03 = RAL9010

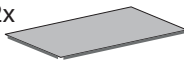
Technická data Technical data Technische Daten			
	100x50 cm	0,7	7,3
	100cm 50cm	1	konzoly/brackets /konsole
	200 cm	1,5	1,4
	48mb	0,47	2x  2x  4x 
* 00 03	Barva Slonová kost Bílá	Color Yvory White	Farbe Perlweiß Weiß
			

Příslušenství Accessories Zubehör				* Barva Color Farbe
1x  4x 	1x Police Shelf Boden 4x Konzoly Brackets Konsole	100x50 (2x50+2x100) (T3.0010501B )	250	7,3
2x  8x 	2x Police Shelf Boden 8x Konzoly Brackets Konsole	100x50 (4x50+4x100) (T3.0010502B )	250	14,6



## *Lahvový regál* *Rack for bottles* *Regal für Flaschen*

160x80x35



**CZ**





Regál typu Variant 160x80x35cm místo polic obsahuje tři páry drátěných sítí 50x80x35cm pro umístění 120 lahví (0,7-1l).





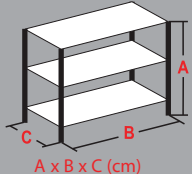
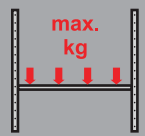

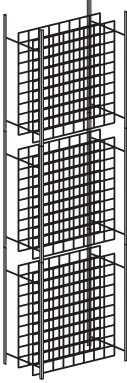



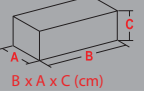

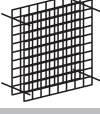

**GB**

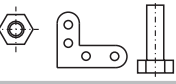

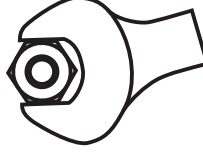

Based on the Variant 160x80x35cm rack, but with three pairs of wire nets 50x80x35cm for stocking of 120 bottles (0,7-1l), instead of shelves.

**D**

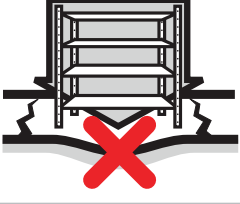
Regal basiert auf dem Typ Variant 160x80x35cm enthält statt Böden drei Paare Drahtnetze 50x80x35cm für die Lagerung von 120 Flaschen (0,7-1l).

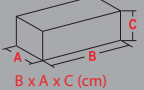
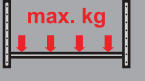
Modul Module Modul	 A x B x C (cm)	Police Shelf Boden	Stojka Upright Säule	 max. kg	 max. kg	 Kg	* Barva Color Farbe
	160x80x35 (LR.6836) (H1.6810)	3x	4x	40x  0,7 - 1 l	200	13,5	00 = RAL1013 03 = RAL9010

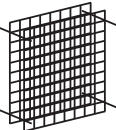
Technická data Technical data Technische Daten	 B x A x C (cm)	 mm	 Kg	
	80x35x50 cm	Ø4 Ø5 2	3,05	Sada = 2x drátěný rošt 80x35x50cm + 4x příčník 1,5x35cm Set = 2x wire net 80x35x50cm + 4x cross beam 1,5x35cm Satz = 2x Drahtnetz 80x35x50cm + 4x Querträger 1,5x35cm
	30x30x160 cm	1	0,62	
	48mb		0,32	48x  M 6x10 2x  48x  M 6 2x  4x 
* 00 03	Barva Slonová kost Bílá	Color Yvory White	Farbe Perlweiß Weiß	  

Příslušenství Accessories Zubehör	 B x A x C (cm)	 max. kg	 Kg	* Barva Color Farbe	
1x 	1x Lahvový rošt Grid for bottles Flaschengitter	80x35x50 (H3.6812)	40x  0,7 - 1 l	3,05	00 = RAL1013 03 = RAL9010





## Opal 4

125x75x30

Do vyčerpání zásob  
Until depletion of stocks  
Bis Erschöpfung des Vorrats

## Opal 3

90x75x30



**CZ**



Perforace polic a oblé trubkové stojáky dodávají regálům OPAL exkluzivní vzhled. Rozteč polic je 38,5cm.







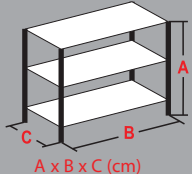
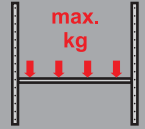

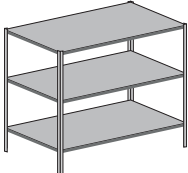
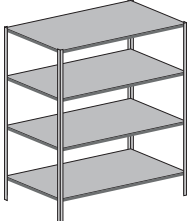

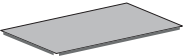

**GB**

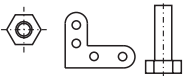
The perforated shelves and rounded uprights give to the Opal racks an exclusive look. The shelf pitch is 38,5cm.

**D**

Perforation von Böden und Rundbögen geben den Regalen OPAL ein exklusives Aussehen. Der Bödenabstand ist 38,5cm.

Modul Module Modul	 A x B x C (cm)	Police Shelf Boden	Stojka Upright Saule	 max. kg	 max. kg	 Kg	* Barva Color Farbe
	Opal 3 90x75x30 (R1.973350)	3x	2x (5Ks-Pcs-Stk)	30	90	6	50 = RAL9005
	Opal 4 125x75x30 (R1.273450)	4x	2x (10Ks-Pcs-Stk)	30	120	8	

Technická data Technical data Technische Daten		 mm	 Kg	
	75x30 cm	0,5	0,82	
	90 cm	ø 20 1mm	0,6	
	125 cm	ø 20 1mm	0,8	
	Opal 4 Opal 3		0,15	16x  M 6x25    4x  M 6x10    20x  M 6    4x  M 6 12x  M 6x25    4x  M 6x10    16x  M 6    4x  M 6

\* Barva Color Farbe  
50 Polomatná černá Half mat black Halbmatt Schwarz

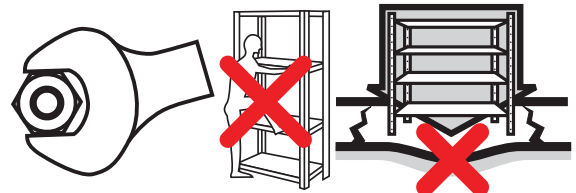



## Shadow 2

185x80x32

Do vyčerpání zásob  
Until depletion of stocks  
Bis Erschöpfung des Vorrats

## Shadow 1

113x80x32

### CZ



Matný zdrsňený povrch antracitové barvy dodává regálům elegantní vzhled. Jsou určeny především pro kanceláře a domácí pracovní. Rozteč polic, která je 35cm, lze velice dobře využít pro kancelářské pořadače.







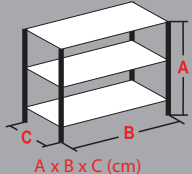
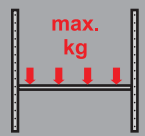

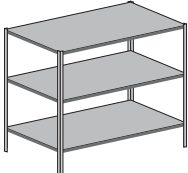
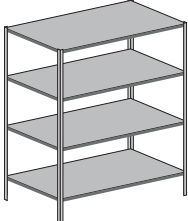

### GB

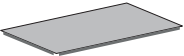
A mat rough surface of anthracite colour gives an elegant visual aspect to the shelves. First of all they can be used for offices and study rooms. The shelf pitch of 35 cm is ideal for office binders.

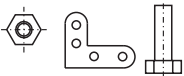
### D

Glanzlose aufgerauhte Oberfläche mit Anthrazit-Farbe gibt den Regalen ein elegantes Aussehen. Sie sind besonders bestimmt für Büros und Studentenzimmer. Der Bödenabstand von 35cm ist ideal für Ringbücher.

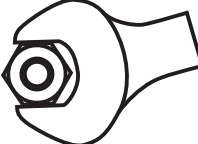
Modul Module Modul	 A x B x C (cm)	Police Shelf Boden	Stojka Upright Saule	 max. kg	 max. kg	 Kg	* Barva Color Farbe
	Shadow 1 113x80x32 (S1.1834)	4x	4x	30	90	7	43 = Antracit-mat 52 = RAL 7004
	Shadow 2 185x80x32 (S1.8836)	6x	4x	30	120	12,5	

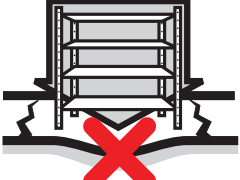
Technická data Technical data Technische Daten	 mm	 Kg	
	80x32 cm	0,5	1,23
	113/4x4-12 cm	0,7	0,74 0,42
	185/4x4-12 cm	0,7	1,33 1
	48 36		0,3
			48x  M 6x10    48x  M 6 36x  M 6x10    36x  M 6
* 43 52	Barva Antracit Signální šedá	Color Antracit Signal grey	Farbe Anthrazit Signalgrau
  			





## *Mini Space* 175x45x30

Do vyčerpání zásob  
Until depletion of stocks  
Bis Erschöpfung des Vorrats



## *Mini* 90x45x30



**CZ**



Mini a Mini Space jsou úzké regály využitelné pro malé prostory. Perforace ve stojce, která umožňuje různé nastavení polic, je 10cm.







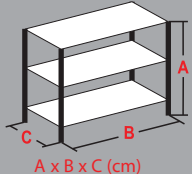
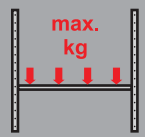

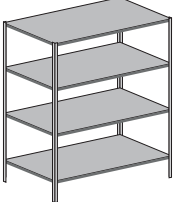
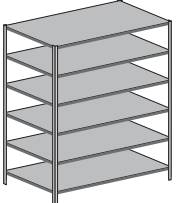
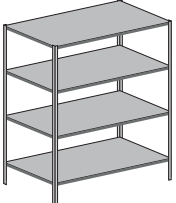

**GB**

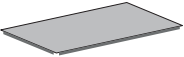

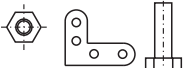

Mini and Mini Space are narrow racks ideal for small spaces. The perforation in the uprights allows various (per 10 cm) shelves setting.

**D**

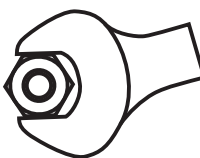
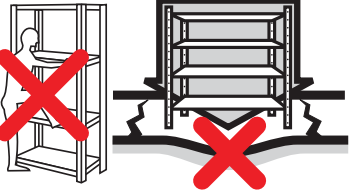
Mini und Mini Space sind schmale Regale, ideal für das kleinen Raum. Die Perforation in der Säule, die verschiedene Positionierung von Böden ermöglicht, ist 10cm.

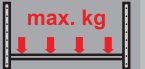
Modul Module Modul	 A x B x C (cm)	Police Shelf Boden	Stojka Upright Säule	 max. kg	 max. kg	 Kg	* Barva Color Farbe
	Mini 90x45x30 (E1.09433)	4x	4x	30	120	5	03 = RAL9010 52 = RAL7036 50 = RAL9005
	Mini Space 175x45x30 (E1.7436)	6x	8x	30	180	8,5	
	Mini Space 175x45x30 (E1.8434)	4x	4x	30	120	6,3	

Technická data Technical data Technische Daten	 mm	 Kg	
	45x30 cm	0,5	0,7
	175/3x3 cm	1	0,64
	90/3x3 cm	1	0,32
	56 mb 40 mb		0,44 0,35
			56x  M 6x10    56x  M 6    4x  40x  M 6x10    40x  M 6    4x 
* 03 52 50	Barva Bílá Platinová šedá Polomatná černá	Color White Platinum grey Half mat black	Farbe Weiß Platingrau Halbmatt Schwarz
	 		

Příslušenství Accessories Zubehör	 B x C (cm)	 max. kg	 Kg	* Barva Color Farbe
1x 	1x Police Shelf Boden 45x30 (E3.4530)	30	0,7	03 = RAL9010 52 = RAL7036 50 = RAL9005
2x 	2x Police Shelf Boden 45x30 (E3.4530)	30	1,4	



## Standard 4

150x75x30

Do vyčerpání zásob  
Until depletion of stocks  
Bis Erschöpfung des Vorrats



## Standard 3

75x75x30



**CZ**



Víceúčelový regál (využití např. dílna, spižárna, sklep apod.) Profilované stojky s perforací a roztečí 40mm umožňují nastavení polic do různých výšek.







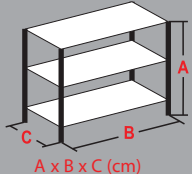
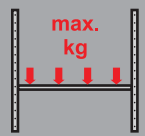

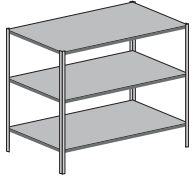
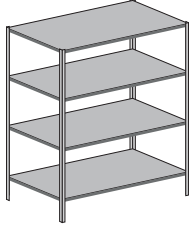
**GB**

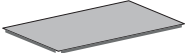

Multi-purpose rack (using e.g. workshop, pantry, cellar etc.) Profiled uprights with a 40 mm pitch perforation enable adjusting shelves in different heights.

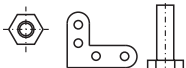
**D**

Mehrzweckregal (Ausnützung z.B. Werkstatt, Speisekammer, Keller u.a.). Profilierte Ständer mit Lochungsabstand von 40mm ermöglichen eine Bödenmontage in verschiedenen Höhen.

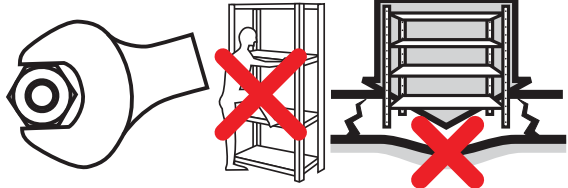
Modul Module Modul	 A x B x C (cm)	Police Shelf Boden	Stojka Upright Säule	 max. kg	 max. kg	 Kg	* Barva Color Farbe
	Standard3 75x75x30 (E1.07733) (P7.0733)	3x	4x	50	200	4,5	00 = RAL1013 03 = RAL9010 55 = hamrsch. 90 = ZN
	Standard4 150x75x30 (E1.5734) (P7.5734)	4x	4x	50	200	7	

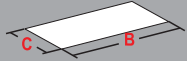
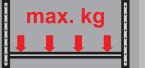
Technická data Technical data Technische Daten	 mm	 Kg	
	75x30 cm	0,5	1,09
	75/3x3 cm	0,6	0,21
	150/3x3 cm (E5.1530)	0,6	0,42
	40vb(E6.P040) 30vb	0,35	40x  M 6x10    40x  M 6    4x  4x 
* 00 03 55 90	Barva Slonová kost Bílá Kladívková šedá Pozink	Color Yvory White Grey hammerite Zinc coated	Farbe Perlweiß Weiß Hammerschlag Verzinkt
			

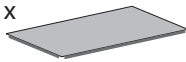
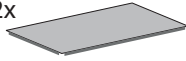
Příslušenství Accessories Zubehör	 B x C (cm)	 max. kg	 Kg	* Barva Color Farbe
1x 	1x Police Shelf Boden	75x30 (E3.7530)	50	1,09
2x 	2x Police Shelf Boden	75x30 (E3.7532)	50	2,18



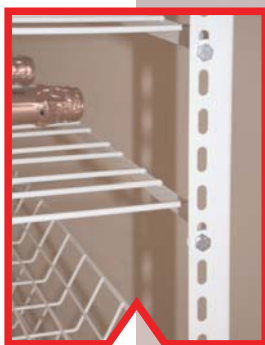

## *Lahvová police* *Shelf for bottles* *Flaschenboden*

### CZ





Lahvová police 80x35cm je použitelná pro regály typu Variant a Varioclick 1/2. Na jedné polici je možné uskladnit osm lahví (objem 0,7-1l).



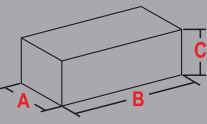
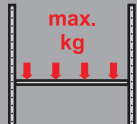

### GB

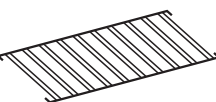

The shelf for bottles 80x35cm can be used for all "Variant" and "Varioclick 1/2" racks. It allows stocking of eight bottles (volume 0,7-1l) on one shelf.

### D

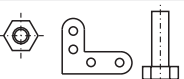
Der Flaschenboden 80x35cm ist für die Regale des Typs "Variant" und "Varioclick 1/2" geeignet. Er ermöglicht die Lagerung bis 8 Flaschen mit Volumen 0,7-1l.

Modul Module Modul	 B x A x C (cm)	Police Shelf Boden		 Kg	* Barva Color Farbe
	80x35 (H3.6815)	2x	8x  0,7 - 1 l	1,95	00 = RAL1013 03 = RAL9010

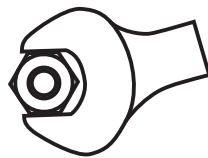
Technická data Technical data Technische Daten		 Kg	
Lahvová police Shelf for bottles Flaschenboden	80x35 cm	Ø4 1,5	1,95 Sada = 2 kusy Set = 2 pieces Satz = 2 Stücke
	8	0,06	8x  M 6x10    8x  M 6
* 00 03	Barva Slonová kost Bílá	Color Yvory White	Farbe Perlweiß Weiß



## *Želeninová police* *Vegetable shelf* *Gemüseboden*

### CZ



Zeleninová police 72x35x5cm je použitelná pro regály typu Variant a Varioclick 1/2. Police je vysouvatelná. Je určena především pro skladování zeleniny, ale je možné ji využít pro mnoho dalších věcí.



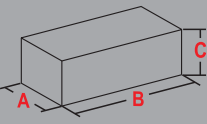
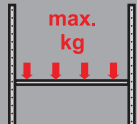

### GB

The vegetable shelf 72x35x5cm can be used for all "Variant" and "Varioclick 1/2" racks. It is possible to draw it in and out. It is used typically for vegetable storage but can be used for many other things.

### D

Gemüseboden 72x35x5cm ist für die Regale des Typs "Variant" und "Varioclick 1/2" geeignet. Ein- und Ausschieben des Bodens ist möglich. Er ist typisch verwendet für die Lagerung von Gemüse, aber kann auch für viele andere Sachen verwendet werden.

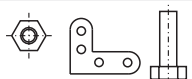
Modul Module Modul	 B x A x C (cm)	Police Shelf Boden		 max. kg	 Kg	* Barva Color Farbe
	72x35x5 (ZP.8035) (H3.6814)	2x		20	5	00 = RAL1013 03 = RAL9010

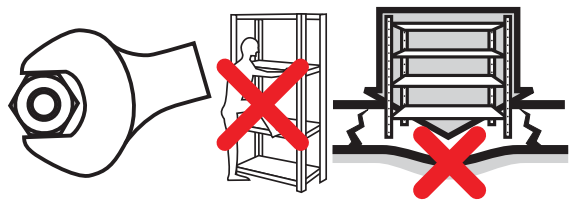
Technická data Technical data Technische Daten			
Zeleninová police Vegetable shelf Gemüseboden	72x35x5 cm	5	Sada = 2x zeleninová police 72x35x5cm + 4x příčník 35x5x5cm/1,5mm Set = 2x vegetable shelf 72x35x5cm + 4x cross beam 35x5x5cm/1,5mm Satz = 2x Gemüseboden 72x35x5cm + 4x Querträger 35x5x5cm/1,5mm
		Ø2 Ø4 Ø5 1,5	
	8	0,06	8x  M 6x10      8x  M 6
* 00 03	Barva Slonová kost Bílá	Color Yvory White	Farbe Perlweiß Weiß
			





## *Lahvový rošt* *Grid for bottles* *Flaschengitter*

### CZ





Lahvový rošt 50x80x35cm je použitelný pro regály typu Variant a Varioclick 1/2. Na jednom páru roštu je možné uskladnit až 40 lahví o objemu 0,7-1l.



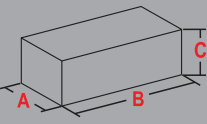
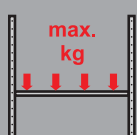

### GB

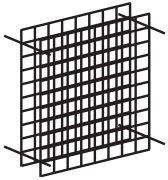
The bottle grid 50x80x35cm can be used for all "Variant" and "Varioclick 1/2" racks. It allows stocking of up to 40 bottles with a volume 0,7-1l per pair of grids.

### D

Das Gitter für Flaschen 50x80x35cm ist für die Regale des Typs "Variant" und "Varioclick 1/2" geeignet. Ein Paar Gitter ermöglicht die Lagerung von bis 40 Flaschen mit Volumen 0,7-1l.

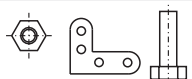
Modul Module Modul	 B x A x C (cm)	Police Shelf Boden	 max. kg	 Kg	* Barva Color Farbe
	80x35x50 (H3.6812)		40x  0,7 - 1 l	3,05	00 = RAL1013 03 = RAL9010

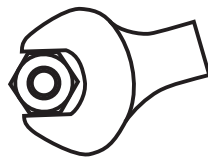
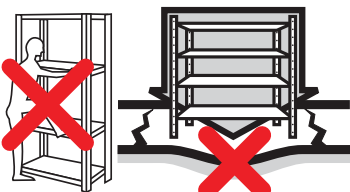
Technická data Technical data Technische Daten			
Lahvový rošt Grid for bottles Flaschengitter	80x35x50 cm	Ø4 Ø5 2	3,05
			Sada = 2x drátěný rošt 80x35x50cm + 4x příčník 1,5x35cm Set = 2x wire grid 80x35x50cm + 4x cross beam 1,5x35cm Satz = 2x Drahtnetz 80x35x50cm + 4x Querträger 1,5x35cm
	16	0,1	16x  M 6x10    16x  M 6
* 00 03	Barva Slonová kost Bílá	Color Yvory White	Farbe Perlweiß Weiß
 			



## *Koš na brambory* *Potato basket* *Kartoffelkorb*

**CZ**



Koš na brambory 50x80x30 cm je použitelný pro regály typu Variant a Varioclick 1/2. Dva páry drátěných roštů vytvoří koš s otvorem ve spodní části, kde je možné odebírat brambory. Přední rošt je rozdělen na dvě části. Je možné odděleně odstranit vrchní část a pohodlně doplnit koš.



**GB**

The potatoe basket 50x80x30 cm can be used for all "Variant" and "Varioclick 1/2" racks. Two pairs of wire grids and an inclined base form a basket with an opening at the bottom, from which is possible to take out potatoes. The front gitter is divided into two parts. Taking away the top part separately allows a comfortable reloading.

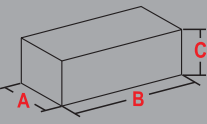
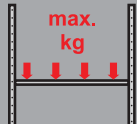
**D**

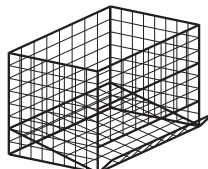
Der Kartoffelkorb 50x80x30 cm ist für die Regale des Typs "Variant" und "Varioclick 1/2" geeignet. Zwei Paare Drahtgitter und ein Boden bilden einen Korb mit einer unteren Öffnung, wo Kartoffeln ausgenommen werden können. Das Vornegitter besteht aus zwei Teile. Entfernung des obenste Teiles individuell ermöglicht eine bequeme Nachfüllung des Korbs.

Modul Module Modul	 B x A x C (cm)			 max. kg	 Kg	* Barva Color Farbe
	80x35x50 (KB.8035) (H3.6816)			50	6,3	00 = RAL1013 03 = RAL9010

Technická data Technical data Technische Daten				
Koš na brambory Potato basket Kartoffelkorb	80x35x50 cm (KB.8035) (H3.6816)	Ø6 Ø3 (Ø5)	6,3	Sada =3x přední-zadní díl 76x20cm + 1x přední díl 76x16cm + 1x dno 74x40cm + 2x bočnice 48x31,5cm Set =3x front-back part 76x20cm + 1x front part 76x16cm + 1x bottom 74x40cm + 2x side 48x31,5cm Satz =3x vorder-hinter Teil 76x20cm + 1x vorder Teil 76x16cm + 1x Boden 74x40cm + 2x Seite 48x31,5cm

* 00 03	Barva Slonová kost Bílá	Color Yvory White	Farbe Perlweiß Weiß	
---------------	-------------------------------	-------------------------	---------------------------	--



# Gondella



Firma Gondella dále vyrábí kompletní regálový systém, který je vhodný pro jakýkoli typ nebo velikost obchodu.



Sowohl in der Tschechischen Werk als in den Belgische Werke produziert Gondella ein komplette modulare Regalsystem geeignet für alle mögliche Verkaufszwecke und -fläche.



Both in the Czech and Belgian production units, Gondella produces a complete system of modular shelving suitable for any store type and size.



## Gondella

Oude Eedstraat 3A  
B-9810 Eke  
Belgium  
t: +32 / 9 / 385 51 26  
f: +32 / 9 / 385 45 54  
Info@gondella.com

Říkov 266  
CZ-552 03 Česká Skalice  
Czech Republic  
t: +420 / 491 / 40 12 11  
f: +420 / 491 / 40 12 12  
Info@gondella.cz





# Gondella

Oude Eedstraat 3A  
B-9810 Eke  
Belgium  
t: +32 / 9 / 385 51 26  
f: +32 / 9 / 385 45 54  
info@gondella.com

Říkov 266  
CZ-552 03 Česká Skalice  
Czech Republic  
t: +420 / 491 / 40 12 11  
f: +420 / 491 / 40 12 12  
info@gondella.cz

<http://www.gondella.com>